

MANTIS Q

Quick Start Guide V1.0

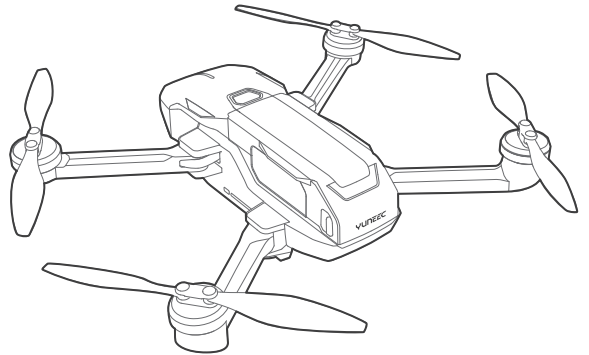

Product Overview

Aircraft

Product Name: Mantis Q

Model: YUNMQA

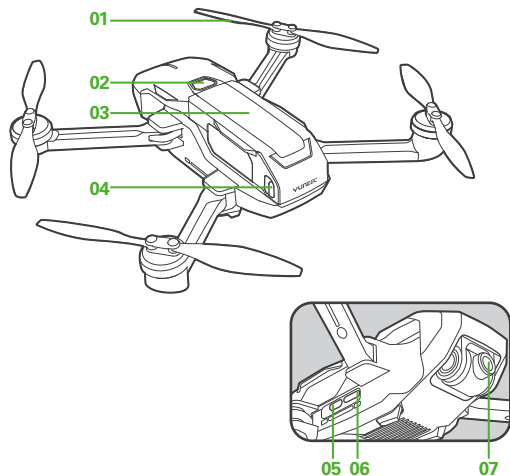

- 01 Propellers
- 02 Power Button
- 03 Battery
- 04 Battery Lock

- 05 USBType-C
- 06 Micro SD Card Slot
- 07 Camera

Controller

Product Name: Mantis Q Remote Controller

Model: YUNMQRC

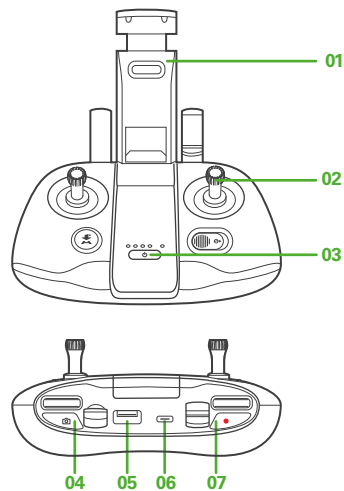

- 01 Phone Holder
- 02 Control Sticks
- 03 Power Button

- 04 Photo Button
- 05 Standard USB Port
- 06 USBType-C
- 07 Video Recording Button

Before Flight

1.Charging the Remote Controller

- Use USB Type-C (only for charging) to charge, approx. 1 hour.

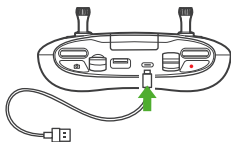

2.Preparing the Aircraft

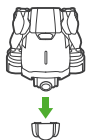

- ▶ Remove the camera protector

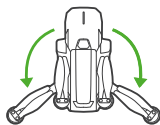

- ▶ Unfold the rear arms

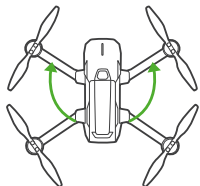

- ▶ Unfold the front arms

- All arms and propellers must be unfolded before powering on.
- To fold the Mantis Q, reverse the unfolding instructions.

3.Charging the Flight Battery

- Press the lock button and remove the flight battery.

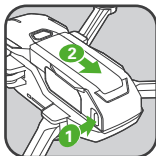

- Charge the flight battery to “Solid Green”, approx. 1.5 hours.

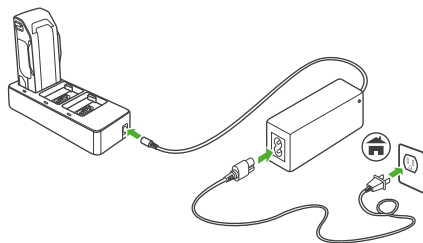

- Push the flight battery into the aircraft until hearing a ‘click’.

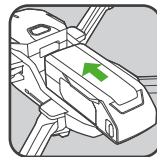

4.App Download

- Download Yuneec Pilot App. Mantis Q supports iOS 9.0 (or later) or Android 5.0 (or later).



First Flight Part 1

1. Installing the Smart Device

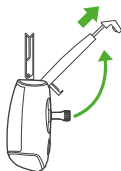

▶ Pull out the phone holder

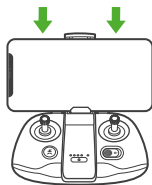

▶ Install the smart phone

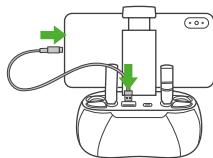

▶ Connect the smart phone with the remote controller (Iphone and Android cable not included)

2. Power On

To power on the Mantis Q and the remote controller, press and hold the power button for two seconds until you hear two rising tones.

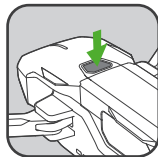

▶ Power on the Mantis Q

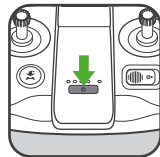

▶ Power on the controller

3. Connecting to Mantis Q

- Launch Yuneec Pilot App.
- Follow on screen directions to connect phone or controller to the aircraft.
- For manual connection through WiFi, the password is:1234567890.

4. Take Off

- To ensure safe flight, step back approximately 9ft (3m) behind the Mantis Q.

Option 1

Tap the icon [] on the app and then slide to take off.

Option 2

- Move the sticks for 1.5 seconds as shown below to start the motors.
- Slowly raise Left Stick to take off.

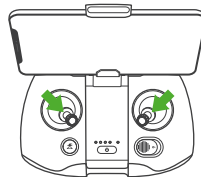

▶ Start the motors.

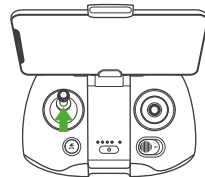

▶ Take off

First Flight Part 2

1.Direction Control

Move the control sticks as below to control the direction of the Mantis Q.

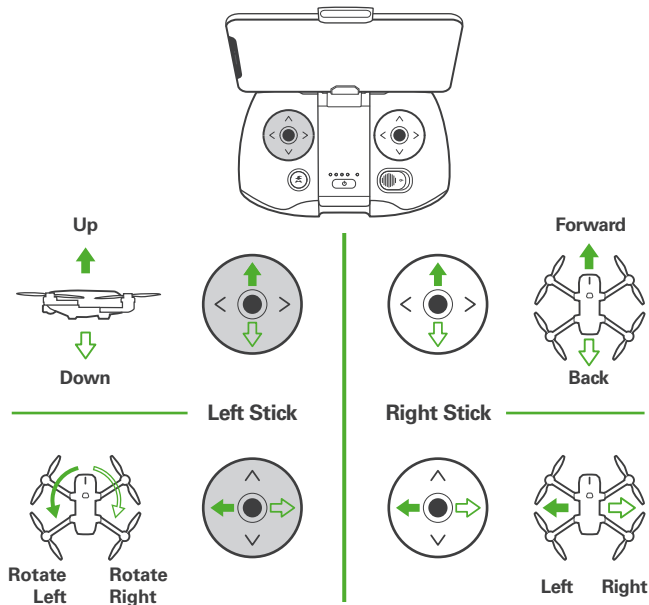

2.Landing

Option 1

Tap the icon [] on the app and then slide to land.

Option 2

Slowly lower Left Stick to land. To land properly, ensure that the aircraft is away from any obstacles or obstructions as it will land directly below where it is hovering.

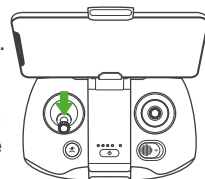

3.Power Off

- To power off the Mantis, press and hold the power button for two seconds.
- To power off the controller, press and hold the power button at the center of the controller for two seconds.

* If you experienced a slight drift during your first flight, it may be best to calibrate your compass. Please go to the Settings section within your app and follow the on-screen instructions to calibrate the compass.

YUNEEC

Any information might be changed due to the software update. For the latest documents, please check the official website: www.yuneeec.com